

MIN 2500-6000 TL-XH Quick Guide

1. Overview

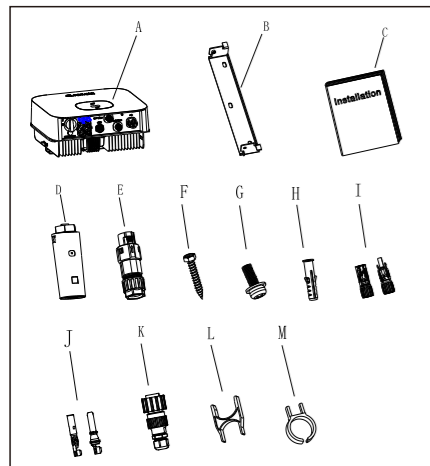

Object	Description	Quantity
A	Inverter	1
B	Mounting bracket	1
C	Quick Guide	1
D	Monitor(Optional)	1
E	Signal connector	2
F	Self-tapping screws	3
G	Safety-lock screw	1
H	Plastic expansion pipe	3

I	PV+/PV- terminal	2/2
J	PV+/PV- and BAT+/BAT- metal terminal	3/3
K	AC connector	1
L	Uninstall signal or AC connector tool	1
M	Uninstall PV or BAT terminal tool	1

Notice:
Before installing the device, check that the package contents are intact and complete against the packing list. If any damage is found or any component is missing, contact your dealer.

2. Installing the Device

2.1 Installation Requirements

Tilt and Space

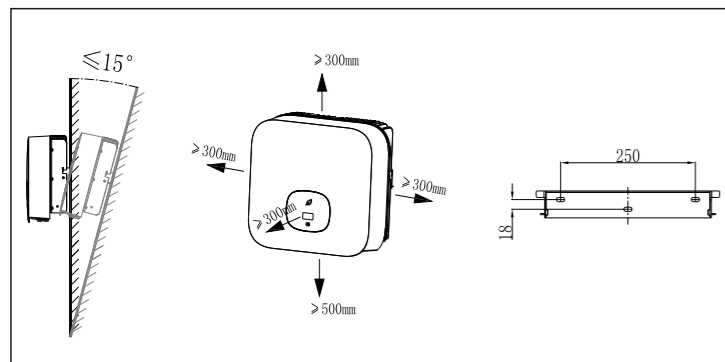

2.3 Installing the Monitor

Ensure that the Monitor is installed securely.

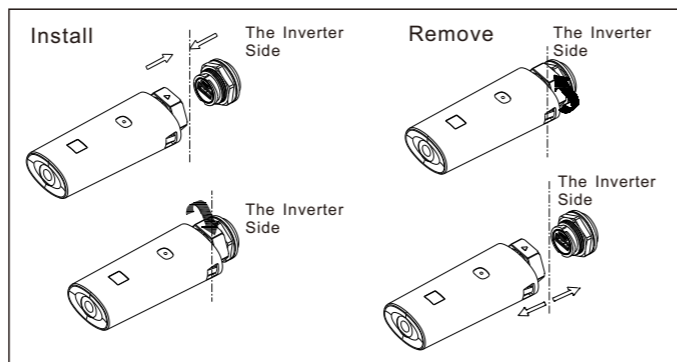

2.2 Installing the Mounting Bracket And Min 2500-6000 TL-XH

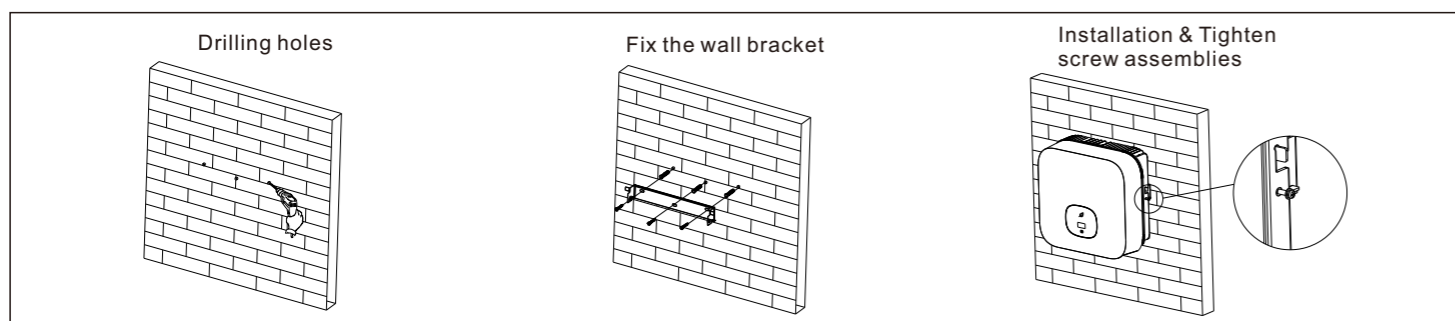

3. Connecting Cables

3.1 Installing the PV Input Power Cable

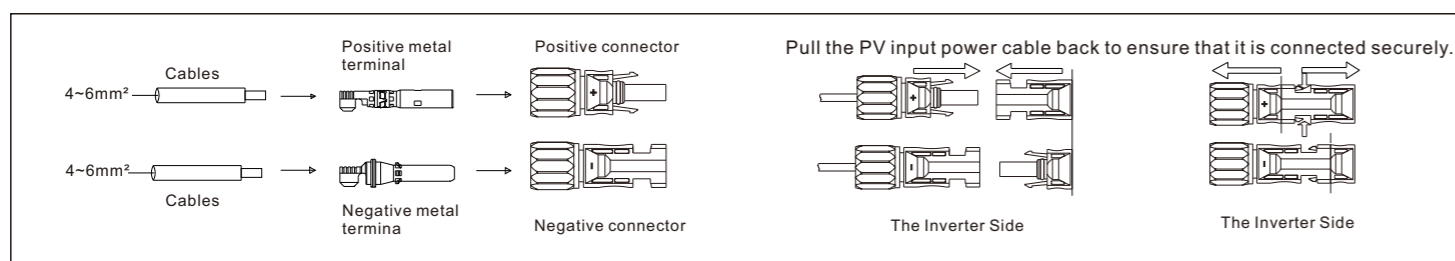

3.2 Installing the BAT Input Power Cable

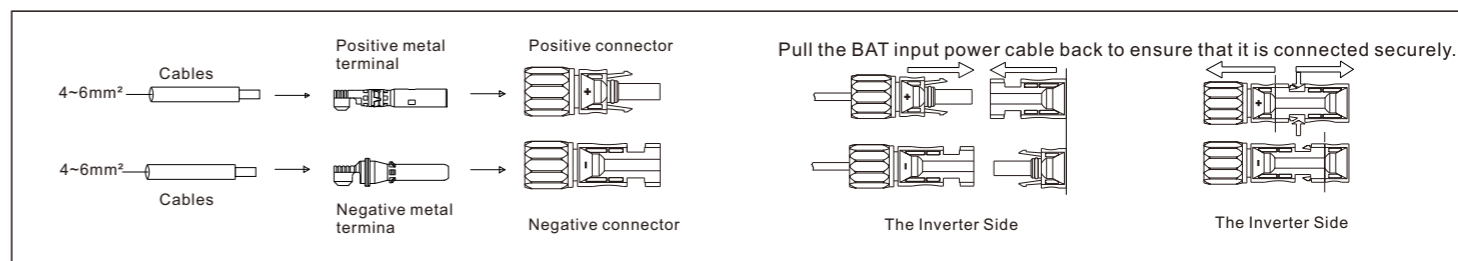

3.3 Installing the AC Output Power Cable

Connect the AC output power cable to the AC connector.

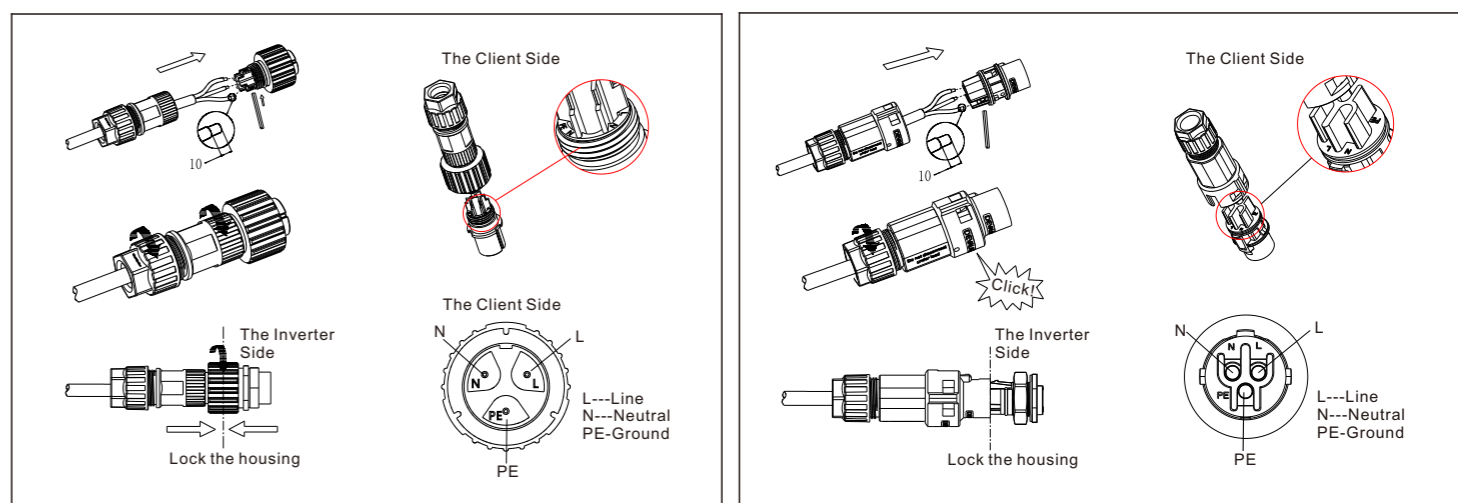

Notice: On the right is the Australian special AC connector. Suggest using 6mm² cables. Ensure the exposed core wire is totally inserted into the cable hole and connected securely.

3.4 Installing the SYS COM Signal Cable

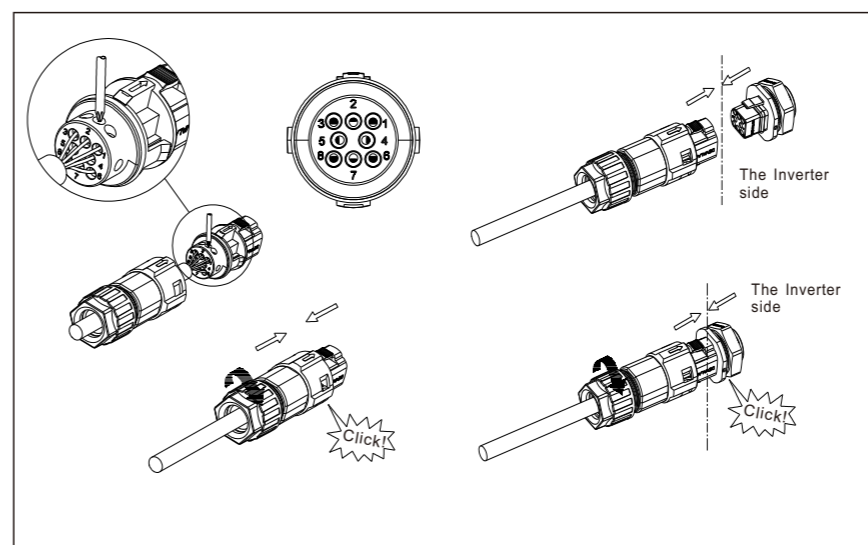

SYS COM Port Pin Definitions

NO	Definition
1	Enable-: Connect BDC enable signal port negative
2	Enable+: Connect BDC enable signal port positive
3	RS485A2: Connect Min ShineBus or Third party monitoring equipment
4	RS485B2: Connect Min ShineBus or Third party monitoring equipment
5	RS485A1: Signal for meter
6	RS485B1: Signal for meter
7	BAT-B: Connect BDC communication RS485B or CANL
8	BAT-A: Connect BDC communication RS485A or CANH

3.5 Installing the COM Signal Cable

We use 8Pin COM Port Connector as Power Control Interface(PCI) for European models or Connector as inverter DRED connection(DRM) for Australia.

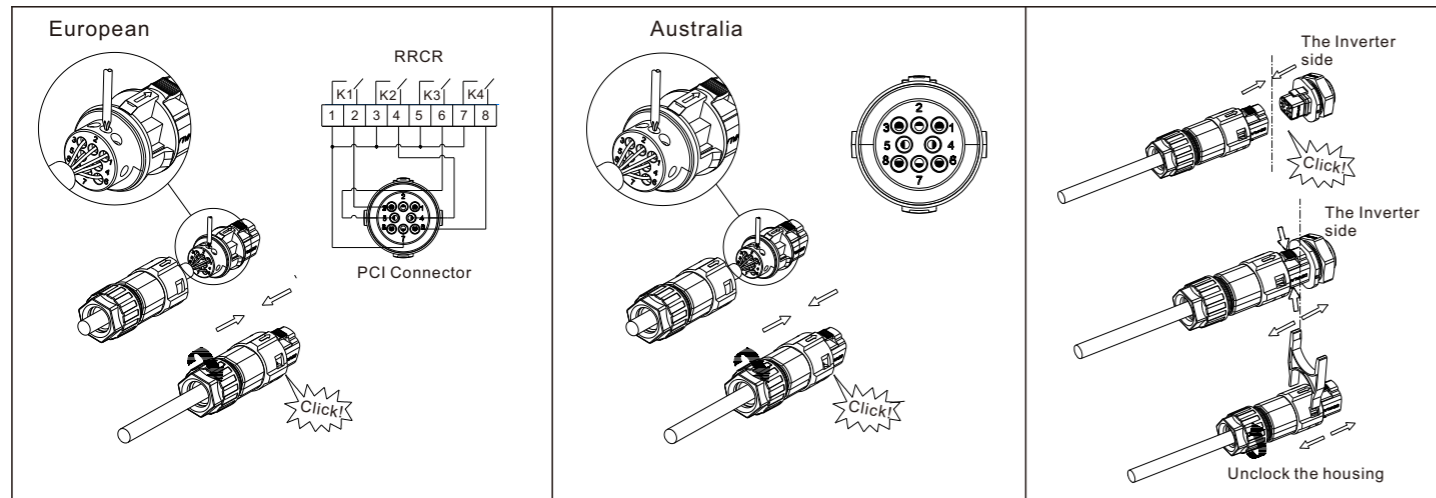

COM Port Pin Definitions- Power Control Interface(PCI).

NO	1	2	3	4	5	6	7	8
Function	+12V	GND	Relay contact 1 input	Relay contact 2 input	Relay contact 3 input	Relay contact 4 input	GND	Not connected
Connect to RRRCR	Not connected		K1- output	K2- output	K3- output	K4- output	Relays common node	Not connected

COM Port Pin Definitions- DRED connection

NO	1	2	3	4	5	6	7	8
Function	+12V	GND	DRM1/5	DRM2/6	DRM3/7	DRM4/8	REFGEN	COM/DRM0

Notice:

1. When laying out signal cables, separate them from power cables to avoid strong signal interference sources.
2. Do not confuse the connector to the COM port and the connector to the SYS COM port.
3. The COM port Aonly provides a functional port-PCI or DRM.

4. Connecting Meter

The following table describes how we can connect EASTRON meter (SDM230-Modbus) to inverter:

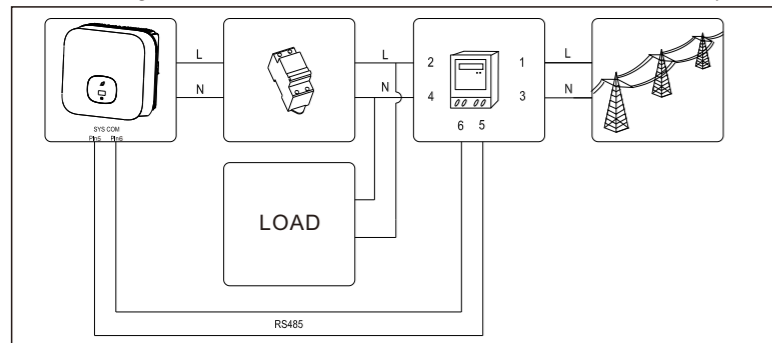

Meter Pin NO.	Description	Connect to Inverter
1	L-in	/
2	L-out	AC connector & Load L
3	N-in	/
4	N-out	AC connector & Load N
5	RS485A	SYS COM Pin 5 RS485A1
6	RS485B	SYS COM Pin 6 RS485B1

The following table describes how we can connect CHINT meter (DDSU666) to inverter:

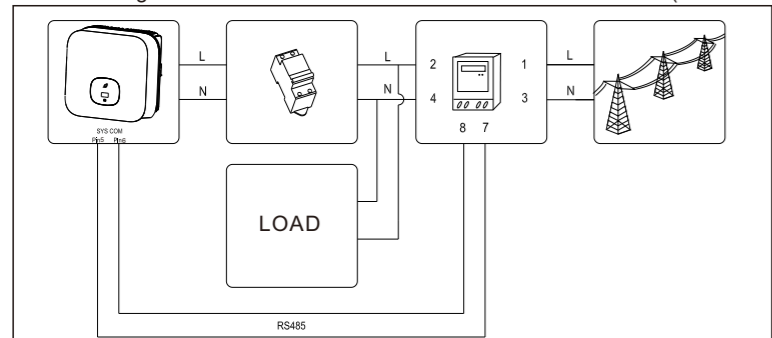

Meter Pin NO.	Description	Connect to Inverter
1	L-in	/
2	L-out	AC connector & Load L
3	N-in	/
4	N-out	AC connector & Load N
7	RS485A	SYS COM Pin 5 RS485A1
8	RS485B	SYS COM Pin 6 RS485B1

5. Verifying the Installation

1. The Min 2500-6000TL-XH is installed correctly and securely.
2. The Monitor is installed correctly and securely.
3. The Ground cable is connected correctly and securely.
4. The DC switch and all the switches connecting to the Min 2500-6000TL-XH are OFF.
5. The AC output power cable, PV&BAT input power cable and signal cable are connected correctly and securely.
6. Unused terminals and ports are locked by watertight caps.

6. Button touch operation

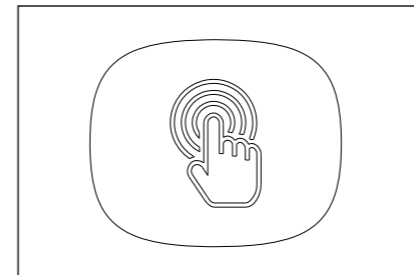

Touch button	Description
Single touch	Switch display or Number +1
Double touch	Enter
Three touch	Previous menu
Hold 5s	Confirm country setting or Number recover default value

7. Powering On the System

Step1: Turn on the DC switch at the bottom of the Min 2500-6000TL-XH.

Step2: Turn on the AC switch between the Min 2500-6000TL-XH and the power grid.
Step3: When the OLED show "Country/Area VDE0126", Please Set the country follow the below step4.

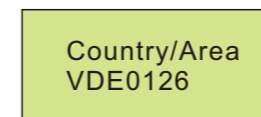

When the OLED show "Country/Area Australia", Please Set the country follow the step5



Step4: Single touch to switch Country, such as N4105, Then jump to step6.

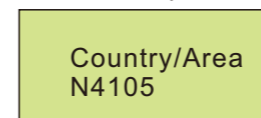

Step5: Single touch to switch Country, such as Newzedland.



Step6: Press the touch key for 5s or No operation on the OLED for more than 30S (The country of the current interface is selected by default)the OLED shows Country setting is complete.

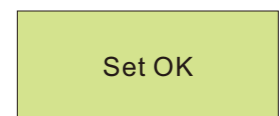

Tips
If the LED light is green, the system is operating normally. You can reset the country by "Set Country" in the submenu of "Set parameter".

SHEN ZHEN WAET TechnologyCo., Ltd
101-102, Block A Fuyu Residence, Pankeng road(No. 108, QindeRoad), Second Industrial Zone, Baihua Community, Guangmingstreet, Guangming District, Shenzhen, P.R.China.
Tel:13802559214
Web:www.waeta.cn



rowatt New Energy

Download Manual